

SHIMANO®

TWIN POWER A-RB

TP-2500FB

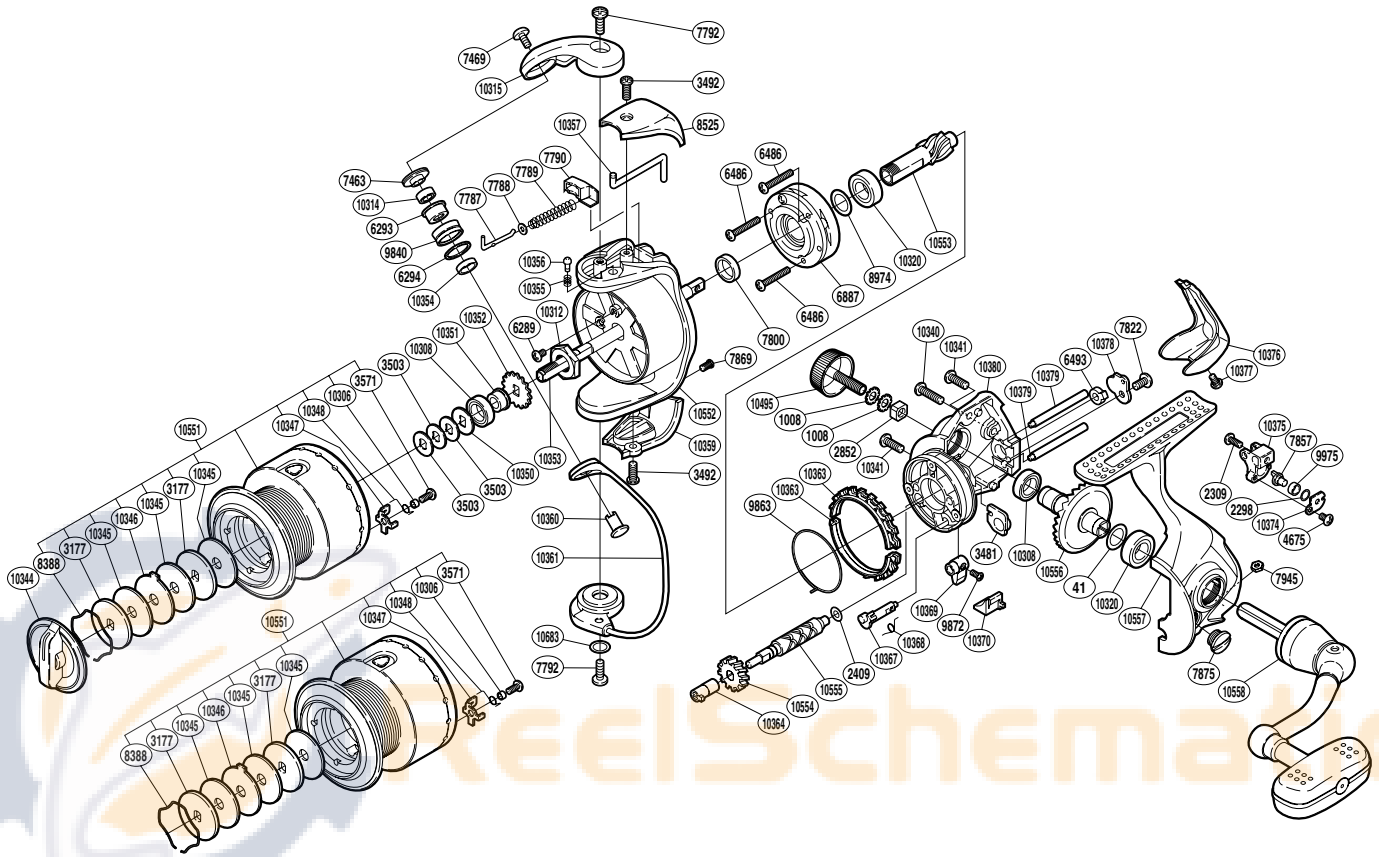

(1SG382502G)

Part No.	Description	Part No.	Description	Part No.	Description
RD 0041	Washer	RD 7875	Oil Cap	RD10357	Bail Trip Lever
RD 1008	Handle Lock Washer	RD 7945	Nut	RD10359	Bail Hold Support Guard
RD 2298	Spacer	RD 8388	Drag Washers Retainer	RD10360	Line Roller Support
RD 2309	Screw	RD 8525	Bail Spring Cover	RD10361	Bail Assembly
RD 2409	Spacer	RD 8974	Washer	RD10363	Friction Ring
RD 2852	Handle Screw Lock	RD 9840	Line Roller	RD10364	Worm Bushing (front)
RD 3177	Key Washer	RD 9863	Friction Spring	RD10367	Anti-Reverse Cam
RD 3481	Bushing	RD 9872	Screw	RD10368	Anti-Reverse Cam Spring
RD 3492	Screw	RD 9975	Oscillating Slider Bushing	RD10369	Anti-Reverse Lever
RD 3503	Spool Washer	RD10306	Drag Click Collar	RD10370	Anti-Reverse Lever Cover
RD 3571	Screw	RD10308	Ball Bearing	RD10374	Oscillating Pawl Cover
RD 4675	Screw	RD10312	Rotor Nut	RD10375	Oscillating Slider
RD 6289	Screw	RD10314	Ball Bearing	RD10376	Rear Protector
RD 6293	Line Roller Bushing	RD10315	Bail Arm	RD10377	Screw
RD 6294	Line Roller Spacer	RD10320	Ball Bearing	RD10378	Worm Shaft Retainer
RD 6486	Screw	RD10340	Screw	RD10379	Oscillating Guide
RD 6493	Worm Bushing (rear)	RD10341	Screw	RD10380	Body
RD 6887	Roller Clutch Assembly	RD10344	Drag Knob	RD10495	Handle Screw Cap
RD 7463	Line Roller Washer	RD10345	Drag Washer	RD10551	Spool Assembly
RD 7469	Screw	RD10346	Eared Washer	RD10552	Rotor
RD 7787	Bail Spring Guide A	RD10347	Drag Click	RD10553	Pinion Gear
RD 7788	Spring Guide A Support	RD10348	Click Spring	RD10554	Idle Gear
RD 7789	Bail Spring	RD10350	Spool Support B	RD10555	Worm Shaft
RD 7790	Bail Spring Seat	RD10351	Bearing Bushing	RD10556	Drive Gear
RD 7792	Screw	RD10352	Spool Support	RD10557	Side Cover
RD 7800	Rotor Ring	RD10353	Main Shaft	RD10558	Handle Assembly
RD 7822	Screw	RD10354	Bearing Spacer	RD10683	Washer
RD 7857	Oscillating Pawl	RD10355	Click Spring		
RD 7869	Screw	RD10356	Click Pin		

(170823)